



# *Convert heat into electricity*

*with the Againty ORC System*

Electricity production from  
Biomass/biogas boilers – Waste incinerators –  
Industrial waste heat – Gas engines/turbines



# Convert heat into electricity

## From heat to electricity

With Againty's innovative ORC turbine your heat production can easily be combined with electricity production.

Againty offers ORC turbines turning low-grade heat into electricity. Biomass boilers, biogas boilers, household waste and industrial waste heat are typical heat sources that can now be utilized for electricity production, thanks to an innovative turbine solution which minimizes pay-back times.

## The ORC technology

Againty's system is based on the long-known ORC technology (Organic Rankine Cycle), which

is illustrated in the image below. The technology includes a steam turbine set in motion by the pressure from hot steam. The rotating turbine then drives a generator that produces electricity. In good conditions the electrical efficiency is 20%.

## Heating and cooling source

To heat up the steam, some kind of heat source is needed. Any heat with a temperature from 90°C can be utilized in the system. After the turbine the steam is cooled down by a cooling system connected to either the outdoor air, a river nearby, or hot tap water for residential buildings, hotels, hospitals or industries.

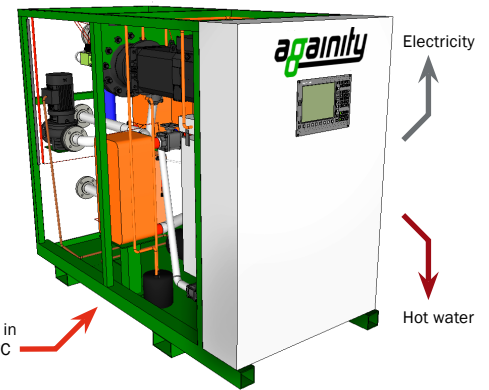

The Againty ORC System. Model AT50.

## Typical heat sources

- Biomass/biogas boiler
- Household waste incinerator
- Waste heat from gas turbine/engine
- Industrial waste heat
- Solar collectors

## Flow chart of the Againty ORC System

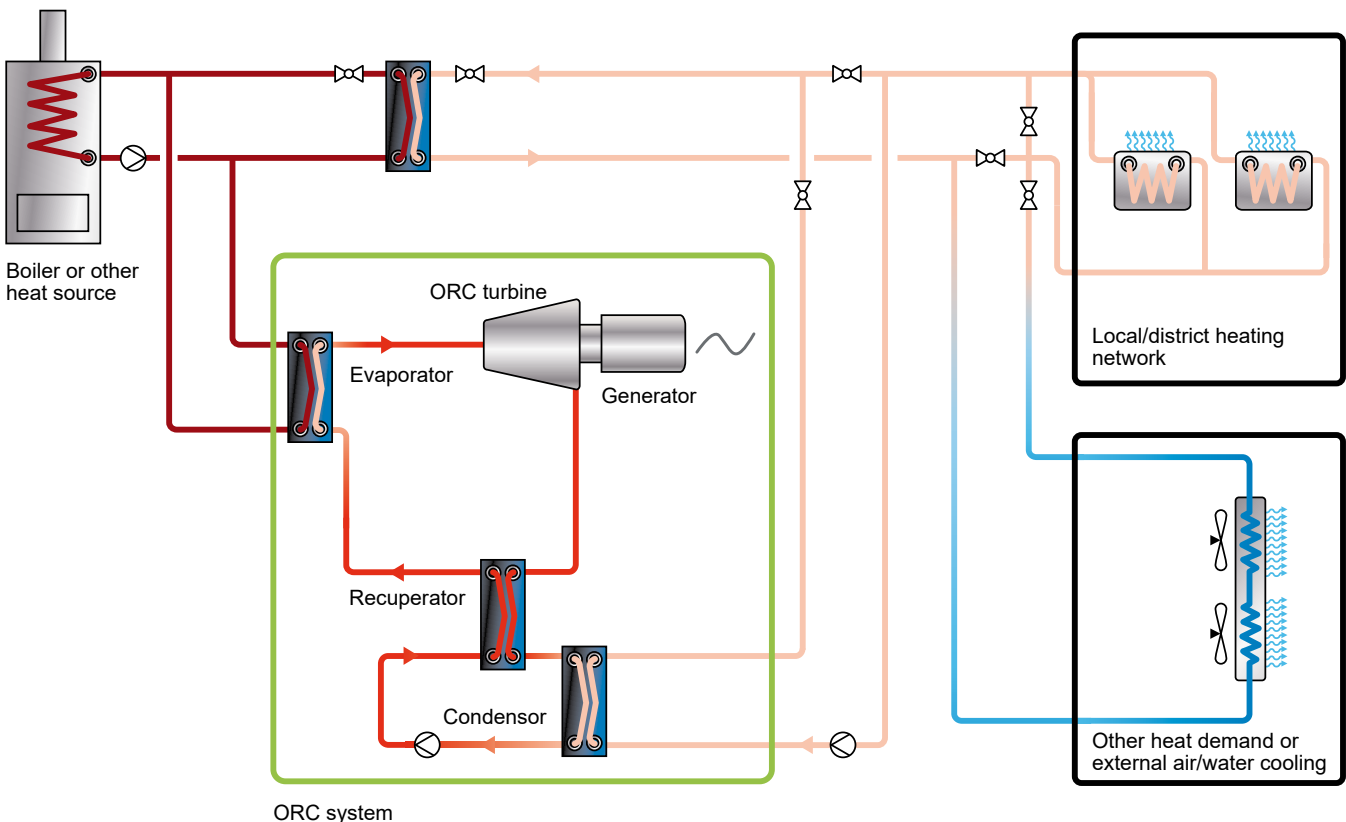

**Locally produced – Cost effective – Fossil free – Weather independent**

### Typical applications

Againity is active in a wide range of industries since the ORC systems can utilize heat from any liquid or gas as long as it exceeds 90°C. Examples of heat sources from our main segments are presented below.

#### Power plants



Waste heat from i.e. gas turbines, diesel engines, or heat from solar collectors.

#### Industrial waste heat



Factories producing aluminum, chemicals, bricks, beverages, etc.

#### Household waste



Incineration of household waste.

#### Biomass boilers

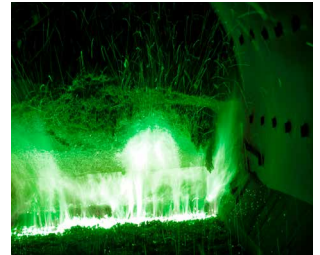

Incineration plants fueled by i.e. wood chips or biogas.

### Quality first

Thanks to the unique design of our patent-pending turbine and the low number of moving parts in the system, a high-quality product can be offered. This minimizes the need for service and maintenance and significantly shortens the payback time.

## Benefits with Againity's ORC solution

### Comprehensive customer offering

- The solution is tailored according to customer needs.
- The offer can include ancillary components such as boilers, cooling equipment, piping, etc.
- The turbine is suitable for various different applications because of the large temperature and power range that can be handled.

### Convenient transportation and installation

- Transport in standard containers or on frame.
- Easy installation with connecting the hot water, cooling water and electricity.
- Short installation time – from 1 week.

### Low investment and operating costs

- OPEX from 0.002 USD/kWh.
- Standardized and modular systems allows a low investment cost.

### High Availability

- Robust system with few moving parts.
- > 97% availability.
- Service from 1 day/year.









# Convert heat into electricity with the Againity ORC System

Againity is all about turning waste heat into something useful – electric power! It's about getting more power out of your existing system. This gives you a more energy efficient production, more performance and less cost – while saving the environment.



## The Againity ORC Systems

The ORC systems are offered from 20 kW electricity and can be combined, hence unlimiting the maximum output. The ORC system is delivered separately or together with a boiler/incinerator/waste heat recovery unit, or other equipment upon request.

	AT20	AT50	AT100	AT200	AT400	AT1000	AT2500
							
Installed capacity	20 kW	50 kW	100 kW	200 kW	400 kW	1000 kW	2500 kW
Size (L*W*H)	2500*1140*2000 mm	2500*1140*2000 mm	3250*2000*2150 mm	6058*2438*2896 mm 20 ft standard high cube container	6058*2438*2896 mm 20 ft standard high cube container	12116*2438*2896 mm 40 ft standard high cube container	18174*2438*2896 mm 40 ft + 20 ft standard high cube container
Voltage <sup>2</sup> Freq.	50-60 Hz	50-60 Hz	50-60 Hz	50-60 Hz	50-60 Hz	50-60 Hz	50-60 Hz
	380-415V	380-415V	380-415V	380-415V	380-415V	3000-6000V	3000-6000V

<sup>2)</sup> Other voltages on request

Copyright © Againity

## Againity AB

Visit and post address: Laxholmstorget 3 (3rd fl), SE-602 21 Norrköping, Sweden

Phone: +46 (0)70 529 32 23, e-mail: info@againity.com

[www.againity.com](http://www.againity.com)

